



***Style, Quality & Performance
Garage Doors***

DoorLink MFG Painting Instructions

Your doorLink Garage Door can be painted using a high quality 100% acrylic latex exterior grade paint. Oil Based or Alkyd Paints may not be used when painting your doorLink Garage Door.

Painting Instructions

Door Preparation -Before painting, door should be free of any surface contaminations such as dirt, dust, oils or waxes. Clean the surface thoroughly by scrubbing with warm soapy water (Do not use an abrasive cleaner). Rinse thoroughly and allow door surface to dry completely.

. Be sure not to sand the surface of the metal door.

Test Paint -It is always a good idea to test a small area of the door prior to painting the entire door. This will test the color and proper adhesion. After the test area has completely dried according to the paint manufacturers instructions you will be able to test the adhesion by using a masking tape. Apply masking tape to the painted area and then peel to check for adhesion.

Painting -Once surface preparation is complete and you have achieved satisfactory results from the paint test you may begin painting your door. The manufacturers painting instructions should be followed painting the door. A second coat of paint should only be applied after the first coat has dried completely according to manufacturer's instructions.

Check manufacturer's instructions for surface temperature range during painting.

For more information on Painting or Maintaining a doorLink Garage Door, please call:
(816)695-0060.

Maintenance- Periodically spray your door off with soap and water and once a year have your door serviced by a qualified garage door company.



410/411

NON INSULATED INSULATED

24 GAUGE

TRADITIONAL RAISED PANEL



410

PAINT

1.0
MIL

411

PAINT

1.0
MIL

EFFICIENCY

6.85
R-VALUE

INTERIOR

VINYL
SKIN

Constructed of top quality materials, highly detailed raised panel, deep woodgrain texture and two coat prefinished paint system all combine to enhance the beauty of your home.

Configure your door on our website at

www.DoorLinkMfg.com

410

NON INSULATED

411

INSULATED

24 GAUGE

TRADITIONAL RAISED PANEL

410/411 STANDARD FEATURES

24 GAUGE METAL

Hot dipped galvanized steel construction with hemmed inside return rail provides superior strength and durability.

1.0 MIL PAINT SYSTEM

Includes .25 mil rust inhibiting primer and .75 mil exterior top coat that resists fading and chalking while providing consistent color from panel to panel, and long life.

ROLLED SAFETY EDGES ON SECTION JOINTS

Eliminates sharp edges, and provides extra strength.

19 GAUGE HOT DIPPED GALVANIZED STILES

Heavy duty metal stiles give strong rigid support for all hinges, rollers and operator attachment.

STILES ATTACHED WITH RIVETS

Provides superior strength when compared to common sheet metal joining methods.

TONGUE AND GROOVE MEETING RAILS

For superior strength and better sealing against wind, rain and snow.

RIGID ALUMINUM RETAINER (Distributor Option)

Provides added strength while securing replaceable u-shaped bottom weatherstrip to help keep the elements out.

411 ADDITIONAL FEATURES

R VALUE 6.85 INSULATION

Enhances your home's energy savings, makes your door operation quieter, and reduces exterior noise in your garage.

CFC FREE EXPANDED POLYSTYRENE

Environmentally friendly insulation that will not degrade with vibration or time.

HIGH IMPACT PLASTIC BACK COVER

Protects the insulation, and enhances the interior look of your garage door.

COLORS



AVAILABLE WINDOWS

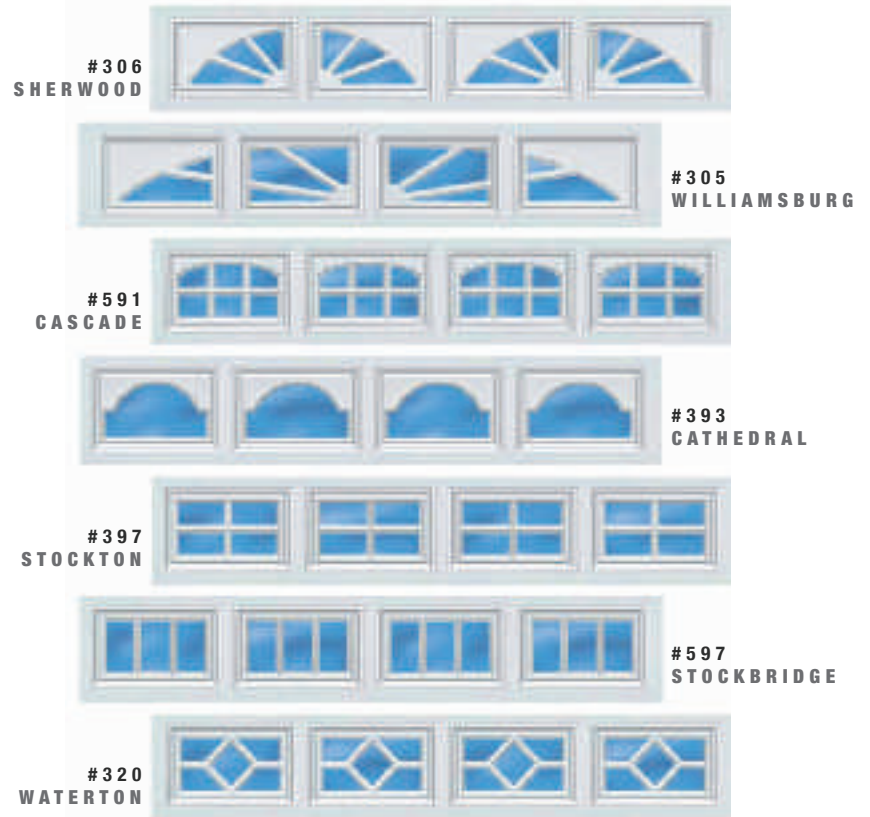

NOT ALL GLAZING OPTIONS MAY BE AVAILABLE FROM ALL DISTRIBUTORS.

SIZES AVAILABLE

DOOR WIDTH	PANELS WIDE	HEIGHTS AVAILABLE: 6'6" 6'9" 7'0" 7'6" 7'9" 8'0"
8', 9'	4	6'6" 6'9" 7'0" 7'6" 7'9" 8'0"
10'	5	6'6" 6'9" 7'0" 7'6" 7'9" 8'0"
12'	6	6'6" 6'9" 7'0" 7'6" 7'9" 8'0"
14', 15'	7	6'6" 6'9" 7'0" 7'6" 7'9" 8'0"
16', 17', 18'	8	6'6" 6'9" 7'0" 7'6" 7'9" 8'0"
20', 22'	9	6'6" 6'9" 7'0" 7'6" 7'9" 8'0"

CONSTRUCTION

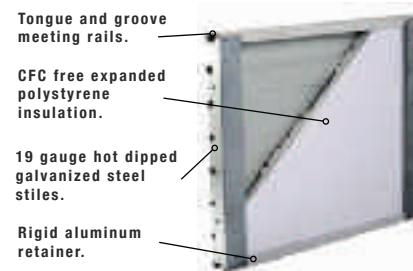

PAINT LAYERS

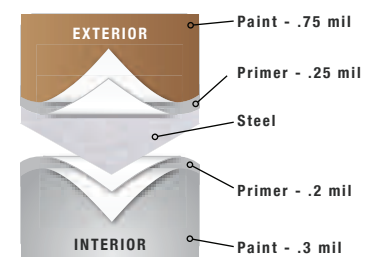

Your Local Authorized Dealer:



To view this product online:



430/431

NON INSULATED INSULATED

24 GAUGE

GROOVED PANEL



430

PAINT

1.0
MIL

431

PAINT

1.0
MIL

EFFICIENCY

6.85
R-VALUE

INTERIOR

VINYL
SKIN

Constructed of top quality materials, highly detailed grooved panel, deep pebblegrain texture and two coat prefinished paint system all combine to enhance the beauty of your home.

Configure your door on our website at

www.DoorLinkMfg.com

430

NON INSULATED

431

INSULATED

24 GAUGE

GROOVED PANEL

430/431 STANDARD FEATURES

24 GAUGE METAL

Hot dipped galvanized steel construction with hemmed inside return rail provides superior strength and durability.

1.0 MIL PAINT SYSTEM

Includes .25 mil rust inhibiting primer and .75 mil exterior top coat that resists fading and chalking while providing consistent color from panel to panel, and long life.

ROLLED SAFETY EDGES ON SECTION JOINTS

Eliminates sharp edges, and provides extra strength.

19 GAUGE HOT DIPPED GALVANIZED STILES

Heavy duty metal styles give strong rigid support for all hinges, rollers and operator attachment.

STILES ATTACHED WITH RIVETS

Provides superior strength when compared to common sheet metal joining methods.

TONGUE AND GROOVE MEETING RAILS

For superior strength and better sealing against wind, rain and snow.

RIGID ALUMINUM RETAINER (Distributor Option)

Provides added strength while securing replaceable u-shaped bottom weatherstrip to help keep the elements out.

431 ADDITIONAL FEATURES

R VALUE 6.85 INSULATION

Enhances your home's energy savings, makes your door operation quieter, and reduces exterior noise in your garage.

CFC FREE EXPANDED POLYSTYRENE

Environmentally friendly insulation that will not degrade with vibration or time.

HIGH IMPACT PLASTIC BACK COVER

Protects the insulation, and enhances the interior look of your garage door.

COLORS



WHITE



SANDSTONE



ALMOND



BROWN



DESERT TAN

BROCHURE COLOR
MAY VARY FROM
ACTUAL PRODUCT.

AVAILABLE WINDOWS



NOT ALL GLAZING OPTIONS MAY BE AVAILABLE FROM ALL DISTRIBUTORS.
NO GLAZING ON 18" SECTIONS.

SIZES AVAILABLE

DOOR WIDTH	PANELS WIDE	HEIGHTS AVAILABLE: 6'6" 6'9" 7'0" 7'6" 7'9" 8'0"
8', 9', 10'	□ □ □ □	
12', 14', 15'	□ □ □ □ □ □	
16', 17', 18'	□ □ □ □ □ □ □ □	
20', 22'	□ □ □ □ □ □ □ □ □ □	

CONSTRUCTION

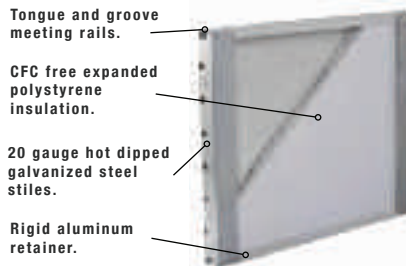

PAINT LAYERS

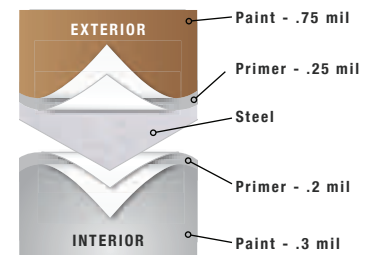

Your Local Authorized Dealer:

To view this product online:



440/441

NON INSULATED INSULATED

24 GAUGE

LONG GROOVED PANEL



440

PAINT

1.0
MIL

441

PAINT

1.0
MIL

EFFICIENCY

6.85
R-VALUE

INTERIOR

VINYL
SKIN

Constructed of top quality materials, highly detailed grooved panel, deep pebblegrain texture and two coat prefinished paint system all combine to enhance the beauty of your home.

Configure your door on our website at

www.DoorLinkMfg.com

440

NON INSULATED

441

INSULATED

24 GAUGE

LONG GROOVED PANEL

440/441 STANDARD FEATURES

24 GAUGE METAL

Hot dipped galvanized steel construction with hemmed inside return rail provides superior strength and durability.

1.0 MIL PAINT SYSTEM

Includes .25 mil rust inhibiting primer and .75 mil exterior top coat that resists fading and chalking while providing consistent color from panel to panel, and long life.

ROLLED SAFETY EDGES ON SECTION JOINTS

Eliminates sharp edges, and provides extra strength.

19 GAUGE HOT DIPPED GALVANIZED STILES

Heavy duty metal styles give strong rigid support for all hinges, rollers and operator attachment.

STILES ATTACHED WITH RIVETS

Provides superior strength when compared to common sheet metal joining methods.

TONGUE AND GROOVE MEETING RAILS

For superior strength and better sealing against wind, rain and snow.

RIGID ALUMINUM RETAINER (Distributor Option)

Provides added strength while securing replaceable u-shaped bottom weatherstrip to help keep the elements out.

441 ADDITIONAL FEATURES

R VALUE 6.85 INSULATION

Enhances your home's energy savings, makes your door operation quieter, and reduces exterior noise in your garage.

CFC FREE EXPANDED POLYSTYRENE

Environmentally friendly insulation that will not degrade with vibration or time.

HIGH IMPACT PLASTIC BACK COVER

Protects the insulation, and enhances the interior look of your garage door.

AVAILABLE WINDOWS



NOT ALL GLAZING OPTIONS MAY BE AVAILABLE FROM ALL DISTRIBUTORS.
NO GLAZING ON 18" SECTIONS.

SIZES AVAILABLE

DOOR WIDTH	PANELS WIDE	HEIGHTS AVAILABLE: 6'6" 6'9" 7'0" 7'6" 7'9" 8'0"
8', 9', 10'		
12', 14'		
15', 16', 17', 18'		
20', 22'		

COLORS



CONSTRUCTION

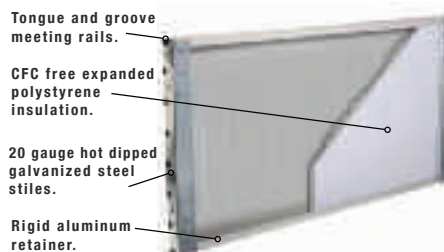

PAINT LAYERS

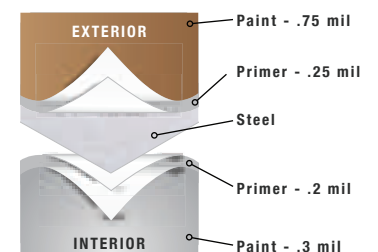

Dynamic Industries

Local Authorized Dealer:

To view this product online:



490/491

NON INSULATED INSULATED

24 GAUGE

RAISED RANCH PANEL



490

PAINT

1.0
MIL

491

PAINT

1.0
MIL

EFFICIENCY

6.85
R-VALUE

INTERIOR

VINYL
SKIN

Constructed of top quality materials, highly detailed raised ranch panel, deep woodgrain texture and two coat prefinished paint system all combine to enhance the beauty of your home.

Configure your door on our website at

www.DoorLinkMfg.com

490

NON INSULATED

491

INSULATED

24 GAUGE

RAISED RANCH PANEL

490/491 STANDARD FEATURES

24 GAUGE METAL

Hot dipped galvanized steel construction with hemmed inside return rail provides superior strength and durability.

1.0 MIL PAINT SYSTEM

Includes .25 mil rust inhibiting primer and .75 mil exterior top coat that resists fading and chalking while providing consistent color from panel to panel, and long life.

ROLLED SAFETY EDGES ON SECTION JOINTS

Eliminates sharp edges, and provides extra strength.

19 GAUGE HOT DIPPED GALVANIZED STILES

Heavy duty metal styles give strong rigid support for all hinges, rollers and operator attachment.

STILES ATTACHED WITH RIVETS

Provides superior strength when compared to common sheet metal joining methods.

TONGUE AND GROOVE MEETING RAILS

For superior strength and better sealing against wind, rain and snow.

RIGID ALUMINUM RETAINER (Distributor Option)

Provides added strength while securing replaceable u-shaped bottom weatherstrip to help keep the elements out.

491 ADDITIONAL FEATURES

R VALUE 6.85 INSULATION

Enhances your home's energy savings, makes your door operation quieter, and reduces exterior noise in your garage.

CFC FREE EXPANDED POLYSTYRENE

Environmentally friendly insulation that will not degrade with vibration or time.

HIGH IMPACT PLASTIC BACK COVER

Protects the insulation, and enhances the interior look of your garage door.

AVAILABLE WINDOWS

306
SHERWOOD



305
WILLIAMSBURG



591
CASCADE



397
STOCKTON



597
STOCKBRIDGE



320
WATERTON

NOT ALL GLAZING OPTIONS MAY BE AVAILABLE FROM ALL DISTRIBUTORS.

SIZES AVAILABLE

DOOR WIDTH	PANELS WIDE	HEIGHTS AVAILABLE: 6'6" 6'9" 7'0" 7'6" 7'9" 8'0"
8', 9', 10'	2	
12', 14'	3	
15', 16', 17', 18'	4	
20', 22'	5	

COLORS



WHITE



SANDSTONE



ALMOND



BROWN



DESERT TAN

BROCHURE COLOR
MAY VARY FROM
ACTUAL PRODUCT.

CONSTRUCTION

Tongue and groove meeting rails.

CFC free expanded polystyrene insulation.

19 gauge hot dipped galvanized steel stiles.

Rigid aluminum retainer.

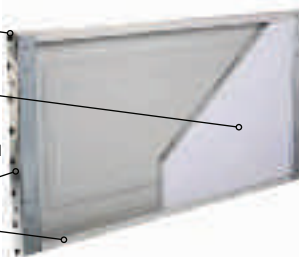

PAINT LAYERS

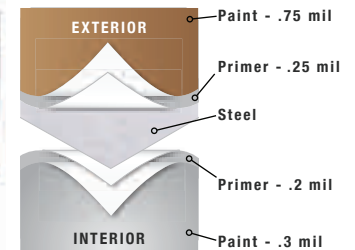

Your Local Authorized Dealer:

To view this product online:



3610

INSULATED

3 LAYER
SANDWICH CONSTRUCTION

TRADITIONAL RAISED PANEL



3610

PAINT	EFFICIENCY
1.0 MIL	10.25 R-VALUE
INTERIOR	
STEEL SKIN	

2" thick insulated steel sandwich panel constructed of top quality materials. Highly detailed raised panel, deep woodgrain texture, and two coat prefinished paint system all combine to enhance the beauty of your home.

Configure your door on our website at

www.DoorLinkMfg.com

TRADITIONAL RAISED PANEL

STANDARD FEATURES

26 GAUGE METAL

Hot dipped galvanized steel construction provides superior strength and durability.

1.0 MIL PAINT SYSTEM

Includes .25 mil rust inhibiting primer and .75 mil exterior top coat that resists fading and chalking while providing consistent color from panel to panel, and long life.

20 GAUGE HOT DIPPED STEEL HINGE PLATES

Galvanized steel hinge plates run the full height of each section at all hinge locations to facilitate the attachment of hinges, handles, struts and step plates.

TONGUE AND GROOVE MEETING RAILS

For superior strength and better sealing against wind, rain and snow.

RIGID ALUMINUM RETAINER (Distributor Option)

Provides added strength while securing replaceable u-shaped bottom weatherstrip to help keep the elements out.

R VALUE 10.25 INSULATION

Sandwich type construction with polystyrene insulation pressure bonded between two sheets of 26 gauge hot dipped galvanized steel enhances your home's energy savings, makes your door operation quieter, and reduces exterior noise in your garage.

CFC FREE EXPANDED POLYSTYRENE

Environmentally friendly insulation that will not degrade with vibration or time.

AVAILABLE WINDOWS

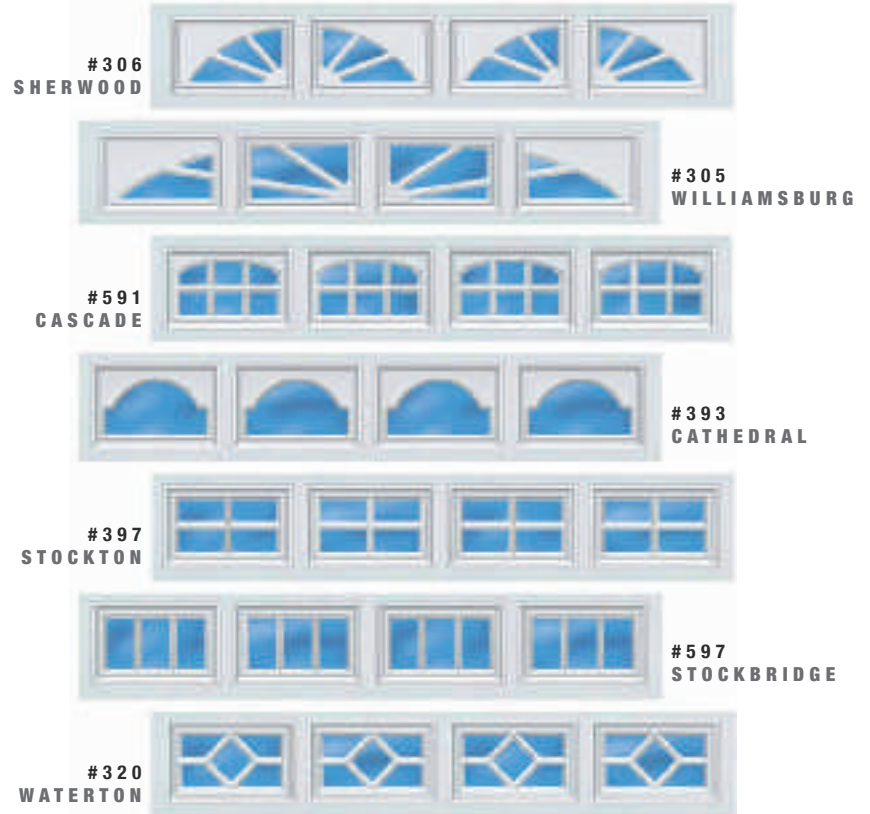

NOT ALL GLAZING OPTIONS MAY BE AVAILABLE FROM ALL DISTRIBUTORS.

SIZES AVAILABLE

DOOR WIDTH PANELS WIDE HEIGHTS AVAILABLE: 6'6" 6'9" 7'0" 7'6" 7'9" 8'0"

8', 9'	□ □ □ □
10'	□ □ □ □ □
12'	□ □ □ □ □ □
14', 15'	□ □ □ □ □ □ □
16', 17', 18'	□ □ □ □ □ □ □ □
20', 22'	□ □ □ □ □ □ □ □ □
24'	□ □ □ □ □ □ □ □ □ □

COLORS



CONSTRUCTION

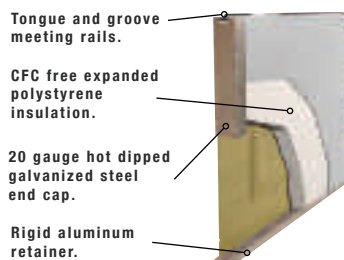

PAINT LAYERS

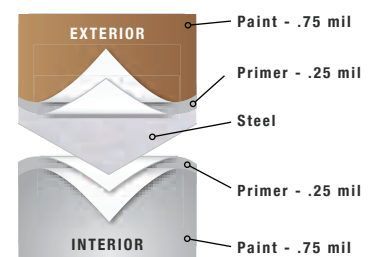

Your Local Authorized Dealer:

To view this product online:



3630

INSULATED

3 LAYER
SANDWICH CONSTRUCTION

GROOVED PANEL



3630

PAINT	EFFICIENCY
1.0 MIL	10.25 R-VALUE
INTERIOR	
STEEL SKIN	



Beautiful wood finishes now available for this model!

2" thick insulated steel sandwich panel constructed of top quality materials. Highly detailed grooved panel, deep pebblegrain texture, and two coat prefinished paint system all combine to enhance the beauty of your home.

Configure your door on our website at

www.DoorLinkMfg.com

3630

**3 LAYER
SANDWICH CONSTRUCTION**

GROOVED PANEL

STANDARD FEATURES

26 GAUGE METAL

Hot dipped galvanized steel construction provides superior strength and durability.

1.0 MIL PAINT SYSTEM

Includes .25 mil rust inhibiting primer and .75 mil exterior top coat that resists fading and chalking while providing consistent color from panel to panel, and long life.

20 GAUGE HOT DIPPED STEEL HINGE PLATES

Galvanized steel hinge plates run the full height of each section at all hinge locations to facilitate the attachment of hinges, handles, struts and step plates.

TONGUE AND GROOVE MEETING RAILS

For superior strength and better sealing against wind, rain and snow.

RIGID ALUMINUM RETAINER (Distributor Option)

Provides added strength while securing replaceable u-shaped bottom weatherstrip to help keep the elements out.

R VALUE 10.25 INSULATION

Sandwich type construction with polystyrene insulation pressure bonded between two sheets of 26 gauge hot dipped galvanized steel enhances your home's energy savings, makes your door operation quieter, and reduces exterior noise in your garage.

CFC FREE EXPANDED POLYSTYRENE

Environmentally friendly insulation that will not degrade with vibration or time.

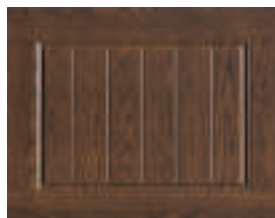

Directional wood grain pattern gives the appearance of traditional wood doors.

COLORS



OAK



WALNUT



WHITE



SANDSTONE



ALMOND



BROWN



DESERT TAN

BROCHURE COLOR
MAY VARY FROM
ACTUAL PRODUCT.

AVAILABLE WINDOWS



388
SOMERTON

287
STOCKTON ARCH

387
STOCKTON

588
WYNDBRIDGE

587
STOCKBRIDGE

NOT ALL GLAZING OPTIONS MAY BE AVAILABLE FROM ALL DISTRIBUTORS.
NO GLAZING ON 18" SECTIONS.

SIZES AVAILABLE

DOOR WIDTH	PANELS WIDE	HEIGHTS AVAILABLE: 6'6" 6'9" 7'0" 7'6" 7'9" 8'0"
8', 9', 10'	□ □ □ □	
12', 14', 15'	□ □ □ □ □ □	
16', 17', 18'	□ □ □ □ □ □ □ □	
20', 22'	□ □ □ □ □ □ □ □ □ □	

CONSTRUCTION

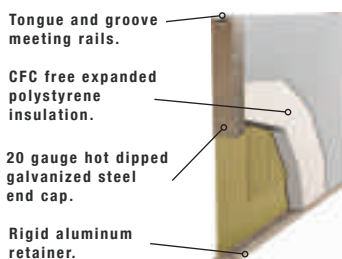

PAINT LAYERS

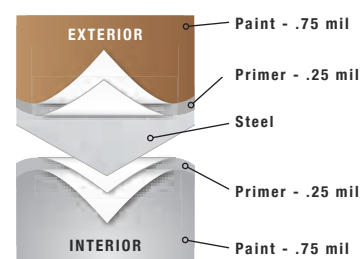

Your Local Authorized Dealer:

To view this
product
online:



3640

INSULATED

3 LAYER
SANDWICH CONSTRUCTION

LONG GROOVED PANEL



3640

PAINT	EFFICIENCY
1.0 MIL	10.25 R-VALUE
INTERIOR	
STEEL SKIN	

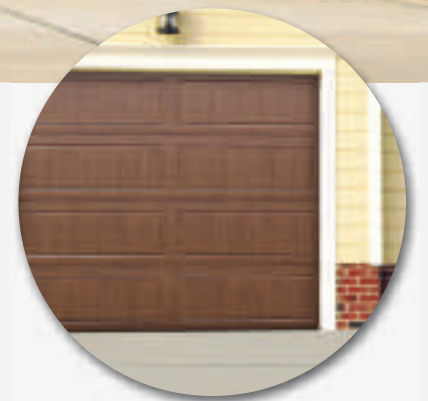

Beautiful wood finishes now available for this model!

2" thick insulated steel sandwich panel constructed of top quality materials. Highly detailed grooved panel, deep pebblegrain texture, and two coat prefinished paint system all combine to enhance the beauty of your home.

Configure your door on our website at

www.DoorLinkMfg.com

3640

**3 LAYER
SANDWICH CONSTRUCTION**

LONG GROOVED PANEL

STANDARD FEATURES

26 GAUGE METAL

Hot dipped galvanized steel construction provides superior strength and durability.

1.0 MIL PAINT SYSTEM

Includes .25 mil rust inhibiting primer and .75 mil exterior top coat that resists fading and chalking while providing consistent color from panel to panel, and long life.

20 GAUGE HOT DIPPED STEEL HINGE PLATES

Galvanized steel hinge plates run the full height of each section at all hinge locations to facilitate the attachment of hinges, handles, struts and step plates.

TONGUE AND GROOVE MEETING RAILS

For superior strength and better sealing against wind, rain and snow.

RIGID ALUMINUM RETAINER (Distributor Option)

Provides added strength while securing replaceable u-shaped bottom weatherstrip to help keep the elements out.

R VALUE 10.25 INSULATION

Sandwich type construction with polystyrene insulation pressure bonded between two sheets of 26 gauge hot dipped galvanized steel enhances your home's energy savings, makes your door operation quieter, and reduces exterior noise in your garage.

CFC FREE EXPANDED POLYSTYRENE

Environmentally friendly insulation that will not degrade with vibration or time.



Directional wood grain pattern gives the appearance of traditional wood doors.

COLORS



OAK



WALNUT



WHITE



SANDSTONE



ALMOND



BROWN



DESERT TAN

BROCHURE COLOR MAY VARY FROM ACTUAL PRODUCT.

AVAILABLE WINDOWS

388
SOMERTON



287
STOCKTON ARCH

387
STOCKTON



588
WYNDBRIDGE

587
STOCKBRIDGE



NOT ALL GLAZING OPTIONS MAY BE AVAILABLE FROM ALL DISTRIBUTORS.
NO GLAZING ON 18" SECTIONS.

SIZES AVAILABLE

DOOR WIDTH	PANELS WIDE	HEIGHTS AVAILABLE: 6'6" 6'9" 7'0" 7'6" 7'9" 8'0"
8', 9', 10'	2	6'6" 6'9" 7'0" 7'6" 7'9" 8'0"
12', 14'	3	6'6" 6'9" 7'0" 7'6" 7'9" 8'0"
15', 16', 17', 18'	4	6'6" 6'9" 7'0" 7'6" 7'9" 8'0"
20', 22'	5	6'6" 6'9" 7'0" 7'6" 7'9" 8'0"
24'	6	6'6" 6'9" 7'0" 7'6" 7'9" 8'0"

CONSTRUCTION

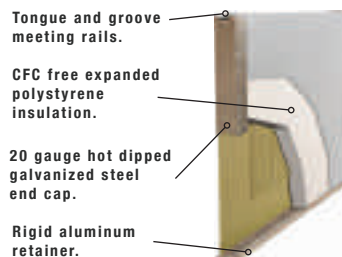

PAINT LAYERS

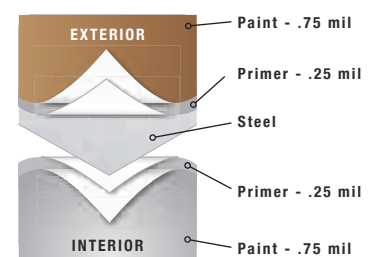

Your Local Authorized Dealer:

To view this product online:



3650

INSULATED

3 LAYER
SANDWICH CONSTRUCTION

FLUSH PANEL

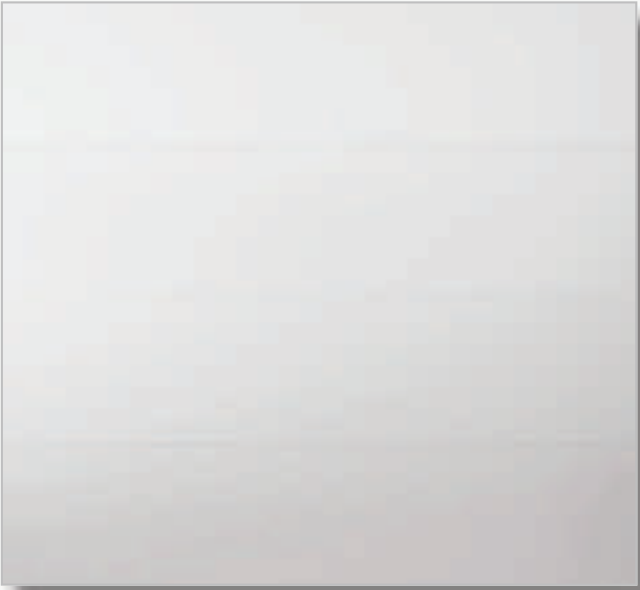

3650

PAINT	EFFICIENCY
1.0 MIL	10.25 R-VALUE
INTERIOR	
STEEL SKIN	

2" thick insulated steel sandwich panel constructed of top quality materials. Flush panel with deep woodgrain texture and two coat prefinished paint system all combine to enhance the beauty of your home.

Configure your door on our website at

www.DoorLinkMfg.com

STANDARD FEATURES

26 GAUGE METAL

Hot dipped galvanized steel construction provides superior strength and durability.

1.0 MIL PAINT SYSTEM

Includes .25 mil rust inhibiting primer and .75 mil exterior top coat that resists fading and chalking while providing consistent color from panel to panel, and long life.

20 GAUGE HOT DIPPED STEEL HINGE PLATES

Galvanized steel hinge plates run the full height of each section at all hinge locations to facilitate the attachment of hinges, handles, struts and step plates.

TONGUE AND GROOVE MEETING RAILS

For superior strength and better sealing against wind, rain and snow.

RIGID ALUMINUM RETAINER (Distributor Option)

Provides added strength while securing replaceable u-shaped bottom weatherstrip to help keep the elements out.

R VALUE 10.25 INSULATION

Sandwich type construction with polystyrene insulation pressure bonded between two sheets of 26 gauge hot dipped galvanized steel enhances your home's energy savings, makes your door operation quieter, and reduces exterior noise in your garage.

CFC FREE EXPANDED POLYSTYRENE

Environmentally friendly insulation that will not degrade with vibration or time.



SIZES AVAILABLE

DOOR WIDTH

8', 9', 10', 12', 14', 15', 16', 17', 18', 20', 22', 24'

HEIGHTS AVAILABLE:

6'6" 6'9" 7'0" 7'6" 7'9" 8'0"

COLORS



WHITE



SANDSTONE



ALMOND



BROWN



DESERT TAN

BROCHURE COLOR
MAY VARY FROM
ACTUAL PRODUCT.

CONSTRUCTION

Tongue and groove meeting rails.

CFC free expanded polystyrene insulation.

20 gauge hot dipped galvanized steel end cap.

Rigid aluminum retainer.

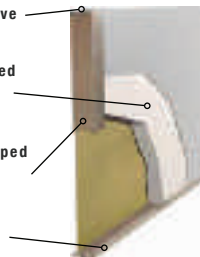

PAINT LAYERS

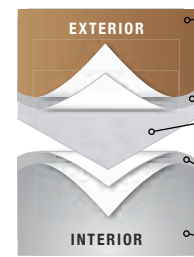

EXTERIOR

- Paint - .75 mil
- Primer - .25 mil
- Steel
- Primer - .25 mil
- Paint - .75 mil

INTERIOR



Dynamic Industries

Your Local Authorized Dealer:

To view this product online:



3690

INSULATED

3 LAYER
SANDWICH CONSTRUCTION

RAISED RANCH PANEL



3690

PAINT	EFFICIENCY
1.0 MIL	10.25 R-VALUE
INTERIOR	
STEEL SKIN	

2" thick insulated steel sandwich panel constructed of top quality materials. Highly detailed raised ranch panel, deep woodgrain texture, and two coat prefinished paint system all combine to enhance the beauty of your home.

Configure your door on our website at

www.DoorLinkMfg.com

STANDARD FEATURES

26 GAUGE METAL

Hot dipped galvanized steel construction provides superior strength and durability.

1.0 MIL PAINT SYSTEM

Includes .25 mil rust inhibiting primer and .75 mil exterior top coat that resists fading and chalking while providing consistent color from panel to panel, and long life.

20 GAUGE HOT DIPPED GALVANIZED STEEL HINGE PLATES

Galvanized steel hinge plates run the full height of each section at all hinge locations to facilitate the attachment of hinges, handles, struts and step plates.

TONGUE AND GROOVE MEETING RAILS

For superior strength and better sealing against wind, rain and snow.

RIGID ALUMINUM RETAINER (Distributor Option)

Provides added strength while securing replaceable u-shaped bottom weatherstrip to help keep the elements out.

R VALUE 10.25 INSULATION

Sandwich type construction with polystyrene insulation pressure bonded between two sheets of 26 gauge hot dipped galvanized steel enhances your home's energy savings, makes your door operation quieter, and reduces exterior noise in your garage.

CFC FREE EXPANDED POLYSTYRENE

Environmentally friendly insulation that will not degrade with vibration or time.

AVAILABLE WINDOWS

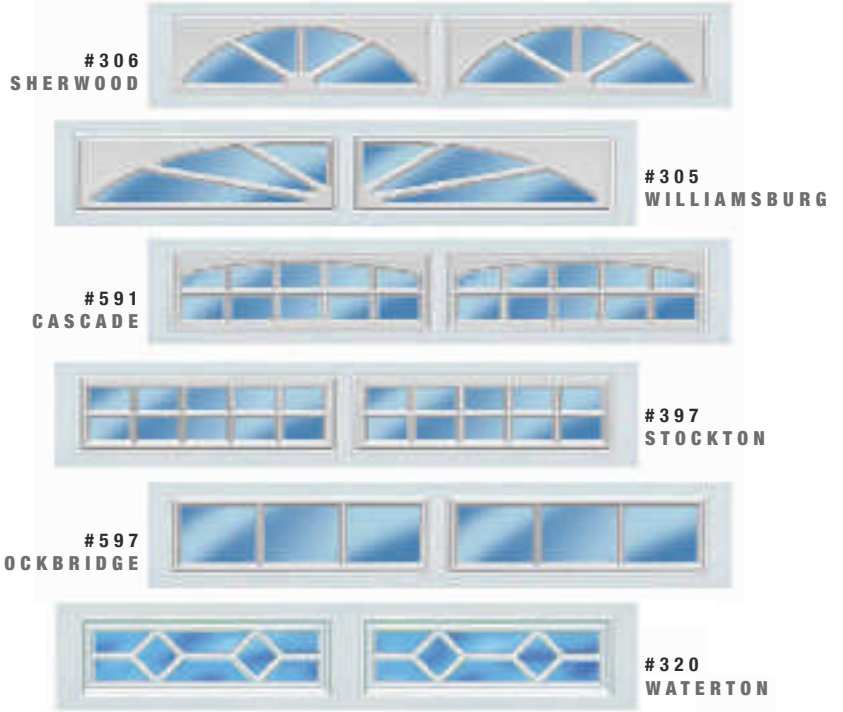

NOT ALL GLAZING OPTIONS MAY BE AVAILABLE FROM ALL DISTRIBUTORS.

SIZES AVAILABLE

DOOR WIDTH	PANELS WIDE	HEIGHTS AVAILABLE: 6'6" 6'9" 7'0" 7'6" 7'9" 8'0"
8', 9', 10'	2	
12', 14'	2	1
15', 16', 17', 18'	2	2
20', 22'	2	3
24'	2	4

COLORS



CONSTRUCTION

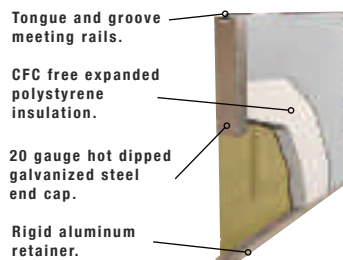

PAINT LAYERS

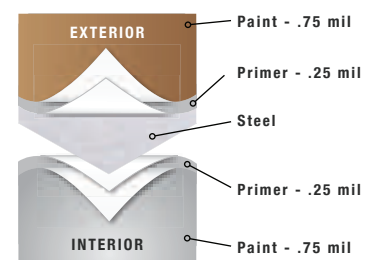

Your Local Authorized Dealer:



To view this product online:



Carriage Creek

3 LAYER
SANDWICH CONSTRUCTION

CARRIAGE HOUSE DOORS



DESERT TAN

Carriage Creek

COLLECTION

PAINT	EFFICIENCY
1.0 MIL	10.25 R-VALUE
INTERIOR	
STEEL SKIN	

All the elegance of a Carriage House door, with the strength and protection of a steel door.

Configure your door on our website at

www.DoorLinkMfg.com

Carriage Creek COLLECTION



CARE INSTRUCTIONS

Carriage Creek Garage Doors are hand-crafted with low maintenance in mind with their steel and composite construction. In order to keep them in excellent condition, we offer these care instructions.

CLEANING

Clean regularly with warm, soapy water only. Do not use an abrasive cleanser.

PAINTING

Use high quality, 100% acrylic latex paint. Use paint with an LRV (Light Reflective Value) greater than 15%. This will exclude some darker colors from being used. The Carriage Creek Warranty will be void if paint with an LRV of 15% or less is used.

MAINTENANCE

Although you should conduct monthly safety checks and provide regular limited maintenance, an annual visit from a trained door technician can keep your door operating safely and smoothly for a long time.



SANDSTONE



SANDSTONE



WHITE



STYLE 1



STYLE 1 ARCH



STYLE 2



STYLE 2 ARCH



STYLE 3



STYLE 4



STYLE 5



STYLE 6



STYLE 7



STYLE 8



AVAILABLE WINDOWS

	PLAIN	STOCKBRIDGE	WYNDBRIDGE	STOCKTON	SOMERTON	STOCKTON ARCH
STYLE 2						
STYLE 3						
STYLE 4						
STYLE 5						
STYLE 6						

ALL SINGLE CAR GARAGE DOOR STYLES ARE ALSO AVAILABLE IN A DOUBLE CAR STYLE.

Carriage Creek

**3 LAYER
SANDWICH CONSTRUCTION**

CARRIAGE HOUSE DOORS

STANDARD FEATURES

2" THICK WITH COMPOSITE OVERLAY

Steel panel sandwich constructed of top quality materials. Overlay chemically bonded to steel sections to give the look of a carriage style door.

1.0 MIL PAINT SYSTEM

Includes .25 mil rust inhibiting primer and .75 mil exterior top coat that resists fading and chalking while providing consistent color from panel to panel, and long life.

20 GAUGE HOT DIPPED STEEL HINGE PLATES

Galvanized steel hinge plates run the full height of each section at all hinge locations to facilitate the attachment of hinges, handles, struts and step plates.

TONGUE AND GROOVE MEETING RAILS

For superior strength and better sealing against wind, rain and snow.

RIGID ALUMINUM RETAINER (Distributor Option)

Provides added strength while securing replaceable u-shaped bottom weatherstrip to help keep the elements out.

R VALUE 10.25 INSULATION

Sandwich type construction with polystyrene insulation pressure bonded between two sheets of hot dipped galvanized steel enhances your home's energy savings, makes your door operation quieter, and reduces exterior noise in your garage.

CFC FREE EXPANDED POLYSTYRENE

Environmentally friendly insulation that will not degrade with vibration or time.

OPTIONAL DECORATIVE HARDWARE

CAST IRON

Decorative Handle Style 1
PN065



Decorative Handle Style 2
PN070



Door Handle



Ring Door Knocker
PN090



PN095

Decorative Hinge Strap and Door Studs



Lift Handle



PN075

STAMPED STEEL

Spade Strap Hinge PN050



Door Handle
PN055



Lift Handle



SIZES AVAILABLE

DOOR WIDTHS:

8', 9', 10'



DOOR WIDTHS:

12', 14'



DOOR WIDTHS:

15', 16', 18'



HEIGHTS AVAILABLE:

6'6" 6'9" 7'0" 7'6" 7'9" 8'0"

COLORS



WHITE



SANDSTONE



ALMOND

BROCHURE COLOR
MAY VARY FROM
ACTUAL PRODUCT.



DESERT TAN

* ALL OVERLAY BOARDS ARE
FINISHED IN WHITE PRIMER ONLY.

CONSTRUCTION

Tongue and groove meeting rails.

CFC free expanded polystyrene insulation.

20 gauge hot dipped galvanized steel end cap.

Rigid aluminum retainer.

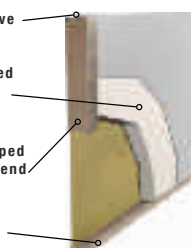

PAINT LAYERS

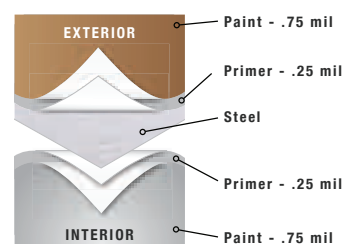

Your Local Authorized Dealer:

To view this product online:



Woodland Creek

WOOD OVERLAY DOORS



Woodland Creek

COLLECTION

FINISH	EFFICIENCY
WOOD OVERLAY	6.85 R-VALUE
INTERIOR	
VINYL SKIN	

Woodland Creek offers the beauty of real wood overlaid on the strength of steel to enhance the beauty of your home.

Configure your door on our website at

www.DoorLinkMfg.com

Woodland Creek

WOOD OVERLAY DOORS

STANDARD FEATURES

AVAILABLE IN SIX DESIGNS

With a complete line of window design options and may be custom ordered from any architectural drawing.

24 GAUGE METAL

Hot dipped galvanized steel construction with hemmed inside return rail and ribbed panel to provide superior strength and durability.

WOOD OVERLAY

Attached chemically to the surface creating a lasting superior bond.

17 GAUGE HOT DIPPED GALVANIZED STILES

Heavy duty metal stiles give strong rigid support for all hinges, rollers and operator attachment.

STILES ATTACHED WITH RIVETS

Provides superior strength when compared to common sheet metal joining methods.

TONGUE AND GROOVE MEETING RAILS

For superior strength and better sealing against wind, rain and snow.

RIGID ALUMINUM RETAINER (Distributor Option)

Provides added strength while securing replaceable u-shaped bottom weatherstrip to help keep the elements out.

R VALUE 6.85 INSULATION

Enhances energy savings, makes your door operation quieter, and reduces exterior noise.

CFC FREE EXPANDED POLYSTYRENE

Environmentally friendly insulation that will not degrade with vibration or time.

HIGH IMPACT PLASTIC BACK COVER

Protects the insulation and allows for easy cleaning.

** All doors are shipped unfinished tight knot cedar.
Optional unfinished clear cedar available.*

WOOD DOOR COLLECTION



Model A



Model B



Model C



Model D



Model E



Model F

OPTIONAL DECORATIVE HARDWARE

CAST IRON

Decorative Handle Style 1
PN065

Decorative Handle Style 2
PN070

Door Handle

Ring Door Knocker
PN090



PN095

Decorative Hinge Strap and Door Studs

Lift Handle



PN075

STAMPED STEEL

Spade Strap Hinge PN050

Door Handle
PN055



Lift Handle

CONSTRUCTION

Tongue and groove meeting rails.

CFC free expanded polystyrene insulation.

17 gauge hot dipped galvanized steel stiles.

Rigid aluminum retainer.

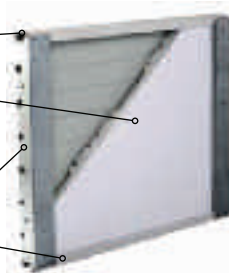

Your Local Authorized Dealer:

To view this product online:



Mill Creek

ALUMINUM CARRIAGE STYLE DOOR



Mill Creek

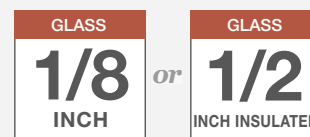

The perfect combination of commercial aluminum strength with elegant carriage style looks. Designed for use in all residential and commercial establishments. Choose from a variety of unique styles and colors to match any need.

Configure your door on our website at

www.DoorLinkMfg.com

Mill Creek

ALUMINUM CARRIAGE STYLE DOOR

STANDARD FEATURES

GLAZING

Sections can be glazed with 1/8" tempered glass or 1/2" insulated glass. Many options are available including tinted glass or low E glass. 0.062" powder coated white aluminum panels can be used in any section.

FINISH

Mill Creek doors have a standard finish of white powder coat. Consult factory regarding custom colors and clear anodized finishes. Doors can also be field painted to match your house's custom color.

WEATHERSTRIP

Bottom rail has a replaceable U type bottom astragal. Optional weather-stripping is available for header and jambs.

OPERATION

Operation to be manual push up, chain hoist, or electric motor.

WIND LOAD

Consult factory for available wind load rated options.

DOOR STYLES

STYLE 2



STYLE 3



STYLE 4



STYLE 5



STYLE 6



AVAILABLE WINDOWS



STANDARD



STOCKBRIDGE



STOCKTON



ARCH



WYNDBRIDGE



SOMERTON

CONSTRUCTION

Doors feature a standard white powder coat finish with custom powder coat colors and clear anodized finishes also available.

2-7/8" or 4-1/4" full tubular top rail depending on door size.

Large 1/8" or 1/2" thick glass panels allow maximum light and visibility.

2-1/8" integral reinforcing fin on lower immediate rail for doors over 12'-2" wide (1/8" glass) or over 10'-2" wide (1/2" glass).

Glass and aluminum panels retained with extruded aluminum snap-in bead.

Replaceable flexible vinyl bottom weatherstrip.

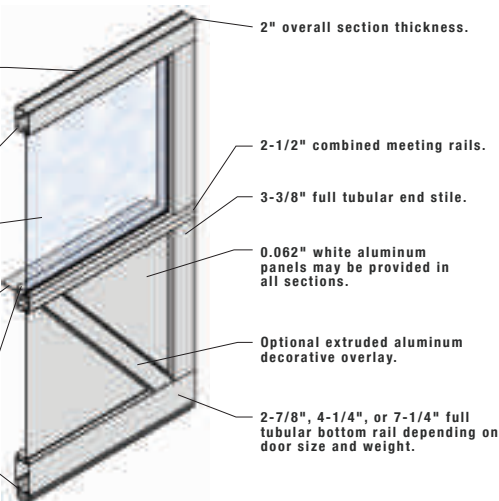

SIZES AVAILABLE



DOOR WIDTHS:

8', 9'

DOOR WIDTHS:

10', 12'

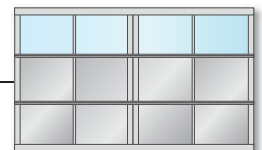

DOOR WIDTHS:

15', 16', 18'

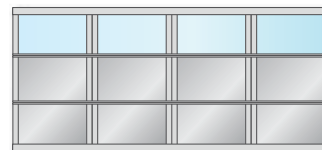

HEIGHTS AVAILABLE:

6'6" 6'9" 7'0" - 3 SECTIONS TALL

7'3" 7'6" 7'9" 8'0" - 4 SECTIONS TALL



Your Local Authorized Dealer:

To view this product online:



4400/4401

NON INSULATED INSULATED

24 GAUGE

PREMIUM COMMERCIAL/INDUSTRIAL STEEL DOORS

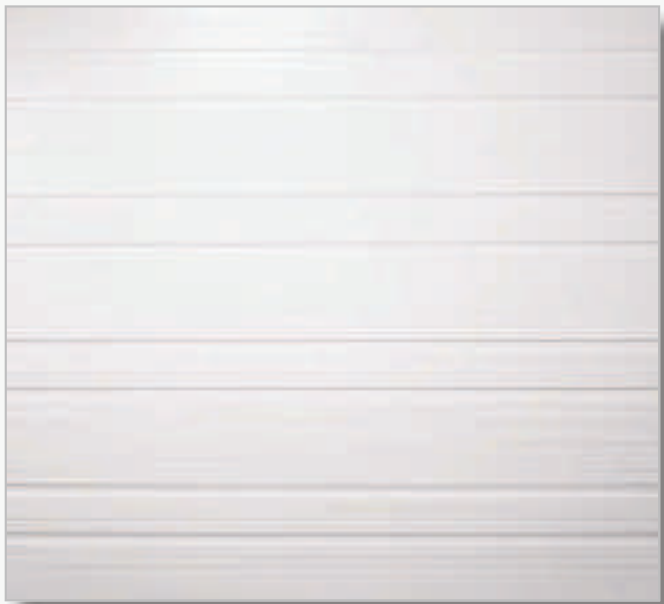

4400 4401

PAINT
1.0
MIL

PAINT
1.0
MIL

EFFICIENCY
6.85
R-VALUE

INTERIOR
VINYL
SKIN

Constructed of top quality materials designed for each application and engineered for years of dependable operation.

Configure your door on our website at

www.DoorLinkMfg.com

4400

NON INSULATED

4401

INSULATED

24 GAUGE

PREMIUM COMMERCIAL/INDUSTRIAL STEEL DOORS

4400 / 4401 STANDARD FEATURES

DOOR SECTIONS

Door sections are galvanized steel and have a 2" thickness. Panels are 24 gauge smooth finish. Sections have tongue and groove meeting rails. Interior flange of panel has a hemmed edge. Panels are formed with two deep ribs and six small grooves. Center and end stiles are 17 gauge galvanized steel. Open sides of stiles have rolled edges. Stiles are mechanically fastened and adhesive bonded to panel to act as an integral structure of the section. Center stiles are shaped to match the profile of the panel.

GLAZING

Options of 24" x 12" or 24" x 4" windows are available. Optional Series 8000 Full View sections can be substituted for steel sections.

INSULATION

Model 4401 doors are insulated with polystyrene insulation. Interior face of insulation is covered with a vinyl protective skin. Insulation R value is 6.85.

TRACK

Galvanized track system is 2" or 3" depending on door size and weight and to be bracket or angle mounted as required.

HARDWARE

Hinges and brackets are made from galvanized steel. Commercial duty rollers are standard.

SPRING COUNTERBALANCE

Springs are oil tempered helical wound and stress relieved torsion springs mounted on a cross header shaft supported by bearing brackets. Springs are calculated for 10,000 door cycles. 25K, 50K, or 100K cycles are optional. Cables are galvanized aircraft quality with a minimum 7 to 1 safety factor.

FINISH

1.0 mil paint system includes .25 mil rust inhibiting primer and .75 mil top coat that resists fading and chalking while providing consistent color from panel to panel.

WEATHERSTRIP

Bottom section has a replaceable U type bottom astragal retained by an extruded aluminum retainer. Optional jambs and header weather-stripping is available.

LOCK

Lock is interior mounted slide lock.

OPERATION

Operation to be manual push up, chain hoist, or electric motor.

WIND LOAD

Consult factory for available wind load rated options.

SIZES AVAILABLE

DOOR WIDTH PANELS WIDE SECTION HEIGHTS: 21" 24"

UP to 9'2"	□ □
9'3" to 12'2"	□ □ □
12'3" to 17'2"	□ □ □ □
17'3" to 18'2"	□ □ □ □ □
18'3" to 24'2"	□ □ □ □ □ □
24'3" to 26'2"	□ □ □ □ □ □ □

COMPLETE DOORS AVAILABLE THROUGH 26' 2"

COLORS



BROCHURE COLOR
MAY VARY FROM
ACTUAL PRODUCT.

CONSTRUCTION

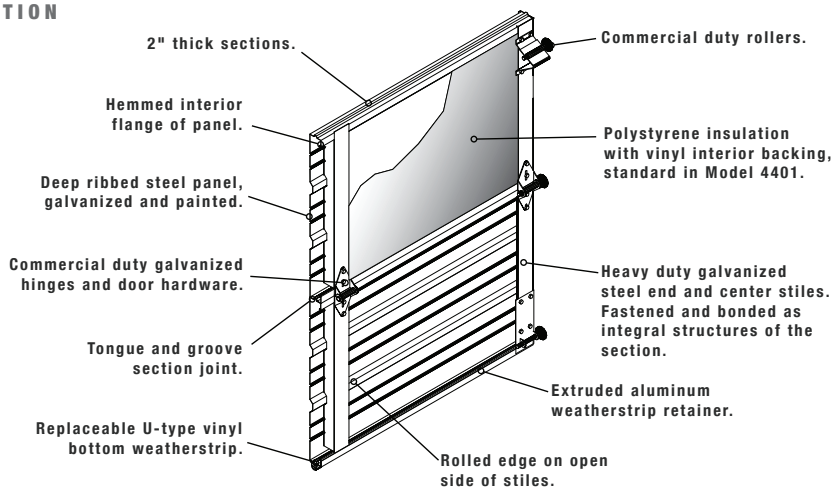

Your Local Authorized Dealer:

To view this
product
online:



6500

INSULATED

3 LAYER
SANDWICH CONSTRUCTION

PREMIUM COMMERCIAL/INDUSTRIAL INSULATED DOORS



6500

PAINT	EFFICIENCY
1.0 MIL	10.25 R-VALUE
INTERIOR	
STEEL SKIN	

Constructed of top quality materials with pebble embossed finish, designed for each application and engineered for years of dependable operation.

Configure your door on our website at

www.DoorLinkMfg.com

PREMIUM COMMERCIAL/INDUSTRIAL INSULATED DOORS

STANDARD FEATURES

DOOR SECTIONS

Door sections have a 2" thickness and are manufactured using an exterior pebble grain embossed nominal 24 gauge steel panel and a 26 gauge steel interior panel with polystyrene insulation pressure bonded to both panels. Sections have tongue and groove meeting rails. Exterior panels are formed with four small grooves. End caps are 20 gauge galvanized steel. 20 steel interior hinge plates are provided for hardware attachment. Plates extend to full height of the section. R value of polystyrene core is 10.25.

GLAZING

24" x 8" or 24" x 12" windows glazed with insulated glass are available. Optional Series 8000 Full View sections can be substituted for steel sections.

TRACK

Galvanized track system is 2" or 3" depending on door size and weight and can be bracket or angle mounted as required. Optional track configurations include high lift, vertical lift, low headroom, and follow the roof pitch.

HARDWARE

Hinges and brackets are made from galvanized steel. Commercial duty rollers are standard.

SPRING COUNTERBALANCE

Springs are oil tempered helical wound and stress relieved torsion springs mounted on a cross header shaft supported by bearing brackets. Springs are calculated for 10,000 door cycles. 25K, 50K, or 100K cycles are optional. Cables are galvanized aircraft quality with a minimum 7 to 1 safety factor.

FINISH

1.0 mil paint system includes .25 mil rust inhibiting primer and .75 mil top coat that resists fading and chalking while providing consistent color from panel to panel. Standard color is white. Brown optional.

WEATHERSTRIP

Bottom section has a replaceable U type bottom astragal retained by an extruded aluminum retainer. Optional jambs and header weather-stripping is available.

LOCK

Lock is interior mounted slide lock.

OPERATION

Operation to be manual push up, chain hoist, or electric motor.

WIND LOAD

Consult factory for available wind load rated options.

SIZES AVAILABLE

DOOR WIDTH	PANELS WIDE	SECTION HEIGHTS: 21" 24"
UP to 9'2"	2	□ □
9'3" to 12'2"	3	□ □ □
12'3" to 17'2"	4	□ □ □ □
17'3" to 18'2"	5	□ □ □ □ □
18'3" to 24'2"	6	□ □ □ □ □ □
24'3" to 26'2"	7	□ □ □ □ □ □ □

COMPLETE DOORS AVAILABLE THROUGH 26' 2"

COLORS



BROCHURE COLOR
MAY VARY FROM
ACTUAL PRODUCT.

CONSTRUCTION

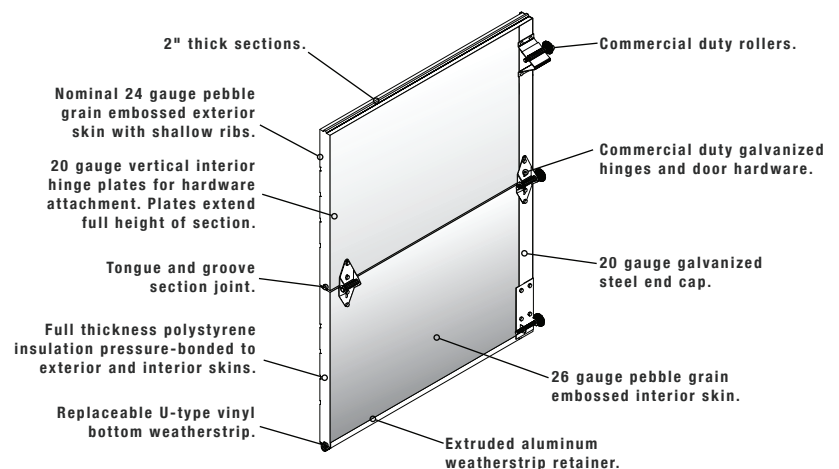

Your Local Authorized Dealer:

To view this
product
online:



8000

PREMIUM ALUMINUM FULL VIEW



8100 8400 8500

GLASS
1/8
INCH

GLASS
1/4
INCH

GLASS
1/2
INCH INSULATED

The right choice when maximum light and visibility are required. Ideally suited for all residential, commercial, and retail establishments. Choose from a variety of glazing options including glass, acrylic, insulated glass or aluminum panels.

Configure your door on our website at

www.DoorLinkMfg.com

8000

PREMIUM ALUMINUM FULL VIEW

STANDARD FEATURES

DOOR SECTIONS

Door sections are 2" thick and consist of extruded aluminum rails and stiles assembled with 5/16" threaded rods and nuts. Glazing is sealed on all four sides and retained on all four sides with extruded aluminum snap-in beads. The end stiles have a visible width of 3 3/8". Center stiles have a visible width of 2 3/4". Top rail has a visible height of 2 7/8" or 4 1/4" depending on door size. Bottom rail has a visible height of 2 7/8", 4 1/4" or 7 1/4" depending on door size and weight.

Combined meeting rails have a visible height of 2 1/2". Lower meeting rail has an integral reinforcing fin on doors over 12' 2" wide (Model 8100) or over 10' 2" wide (Models 8400 and 8500).

GLAZING

Sections can be glazed with 1/8" glass or acrylic (Model 8100), 1/4" glass (Model 8400), or 1/2" insulated glass (Model 8500). Many glazing options are available including tempered glass, tinted glass, low E glass, or laminated safety glass. 0.062" anodized aluminum panels can be used in any section.

TRACK

Galvanized track system is 2" or 3" depending on door size and weight and can be bracket or angle mounted as required. Optional track configurations include high lift, vertical lift, low headroom, and follow the roof pitch.

HARDWARE

Hinges and brackets are made from galvanized steel. Rollers have (10) 1/4" steel ball bearings in case hardened races.

SPRING COUNTERBALANCE

Springs are oil tempered helical wound and stress relieved torsion springs mounted on a cross header shaft supported by bearing brackets. Springs are calculated for 10,000 door cycles. 25K, 50K, or 100K cycles are optional. Cables are galvanized aircraft quality with a minimum 7 to 1 safety factor.

FINISH

All aluminum parts are clear anodized, bronze anodized or white powder coated. Powder coated in custom colors available.

WEATHERSTRIP

Bottom rail has a replaceable U type bottom astragal. Optional weather-stripping is available for header and jambs.

LOCK

Lock is interior mounted slide lock.

OPERATION

Operation to be manual push up, chain hoist, or electric motor.

WIND LOAD

Consult factory for available wind load rated options.

SIZES AVAILABLE

DOOR WIDTH PANELS WIDE SECTION HEIGHTS: 21" 24"

UP to 9'2"	□ □
9'3" to 12'2"	□ □ □
12'3" to 17'2"	□ □ □ □
17'3" to 18'2"	□ □ □ □ □
18'3" to 20'2"	□ □ □ □ □ □

CONSTRUCTION

Aluminum components are clear anodized, bronze anodized or white powder coated. Powder coated in custom colors on request.

Full tubular top rail. 2-7/8" or 4-1/4" depending on door size.

Large glass panels allow maximum light and visibility. Glass thicknesses from 1/8" to 1/2."

2-1/8" integral reinforcing fin on lower meeting rail for doors over 12'-2" wide (Model 8100) or over 10'-2" wide (Models 8400 and 8500).

Glass and aluminum panels retained with extruded aluminum snap in bead.

Replaceable flexible vinyl bottom weatherstrip.

2" thick sections.

2-1/2" combined meeting rails.

3-3/8" full tubular end stile.

0.062" aluminum panels finish to match aluminum frame. Aluminum panels can be provided in all sections.

Full tubular bottom rail. 2-7/8", 4-1/4", or 7-1/4" depending on door size and weight.



Your Local Authorized Dealer:

To view this product online:



Residential Steel Door Warranty

Door Sections:

warrants the door sections against defects in material and workmanship and deterioration due to rust through (defined as metal perforation) in residential single-family, owner occupied installations for as long as the original purchaser owns the home. In all other residential installations for three (3) years, from date of delivery to the original purchaser. Window components are warranted against defects in material and workmanship for three (3) years from date of delivery to the original purchaser. further warrants the Model 3600 Series Steel Doors for a period of five (5) years from the date of installation to the original purchaser against delamination (defined as the separation of front and back steel skins). This warranty specifically excludes weather-stripping which is subject to wear under normal usage. This warranty excludes rust resulting from damage to the door section caused by fire, other accident or casualty, scratches, vandalism, harmful fumes or chemicals, condensation or occurring as a result of any damage.

Hardware & Springs:

warrants all hardware and spring components against defects in material and workmanship in residential single-family, owner occupied installations for five (5) years from date of delivery to the original purchaser. In all other residential installations for three (3) years from date of delivery to the original purchaser.

This warranty does not apply to any damage or deterioration caused by abuse, applied paint failure to provide reasonable, necessary and proper maintenance, or any other causes beyond control, nor shall these warranties extend to or cover any damages or claims with respect to any products that in any way have been altered, processed, misused or improperly handled or installed. This warranty applies to residential products only and is not valid on commercial applications.

Under the terms of this limited warranty, for any door components that are found to be defective upon inspection by authorized personnel, will, at its option, repair or replace the defective components. Labor charges, shippings costs, paint or painting, or other building materials shall be the responsibility of the consumer.

shall not be liable for any consequential or incidental damages. All other warranties, expressed or implied, including any warranty of merchantability are hereby expressly excluded. Some states do not allow the exclusion or limitation of consequential or incidental damages so the above limitation or exclusion may not apply to you.

In the event the door is defective, a claim must be submitted in writing with proof of purchase to

After notification, shall be permitted to inspect the door for verification of defect.

Name of Installation Company: _____

Address of Installation: _____

Date of Purchase: _____



Dynamic Industries

Torsion Spring & Hardware

Canada (Mississauga)
4180 Sladeview Crescent, Unit 2
Mississauga, Ontario L5L 0A1 Canada

Tel: 1.905.607.8868
Fax: 1.905.607.8888
Txt: 905.607.8868
Email: mississauga@dm-ind.com

Canada (Vaughan)
299 Basaltic Road, Unit 4
Concord, Ontario L4K 4W8 Canada

Tel: 1.905.879.5888
Fax: 1.905.879.7888
Txt: 289.814.1941
Email: vaughan@dm-ind.com